



Manual or Automatic - it's your Choice

LKB Automatic or Manual Butterfly Valve

Application

LKB is a sanitary automatically or manually operated butterfly valve for use in stainless steel pipe systems.

Working principle

LKB is either remote-controlled by means of an actuator or manually operated by means of a handle. The actuator is made in three standard versions, normally closed (NC), normally open (NO) and air/air activated (A/A).

The actuator is designed so that an axial movement of a piston is transformed into a 90° rotation of a shaft. The torque of the actuator is increased when the valve disc contacts the seal ring of the butterfly valve.

The handle for manual operation mechanically locks the valve in its open or closed position.

The handles for the valve sizes DN125 and DN150, which are designed for locking in two intermediate positions, enables adjusting of the valve, so that the flow rate can be regulated.

Standard design

LKB is available in three versions, LKB for ISO tubes, LKB-2 for DIN tubes and LKB-F for flange connection.

The valve consists of two valve body halves, valve disc, bushes for the disc stem and seal ring. LKB-F also consists of two flanges and two flange seal rings. The valve is assembled by means of screws and nuts.

Two actuator sizes, ø85mm and ø133mm, cover all valve sizes. The actuator is available in two versions, LKLA and LKLA-T.

The actuator is fitted onto the valve by means of a bracket and screws. (The actuator can also be fitted onto ball valves by means of special brackets).

The handle for manual operation is fitted onto the valve by means of a cap/block system and a screw.

The valve has welding ends as standard, but LKB and LKB-2 can also be supplied with fittings.

Control Equipment

Control and indication is possible in connection with the remote-controlled LKB valve. See "Options".

LKLA-T can be fitted with ThinkTop®.



LKB-F butterfly valve with LKLA actuator

LKB butterfly valve with handle 1.1

Torque diagrams - Actuator

LKLA ø85 mm:

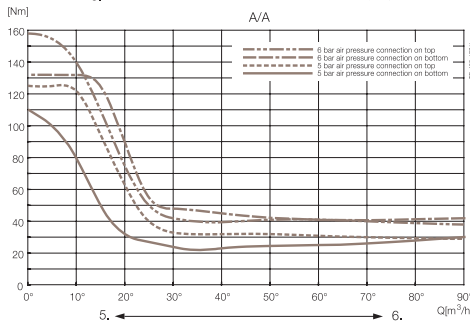
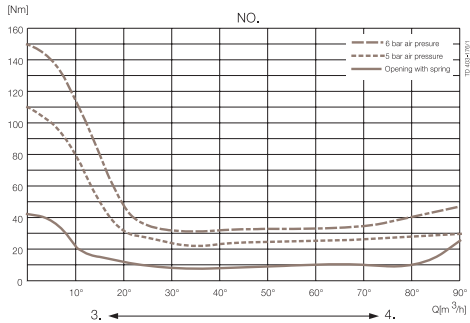
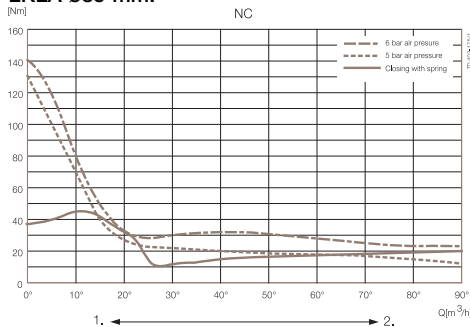

LKLA ø133 mm:

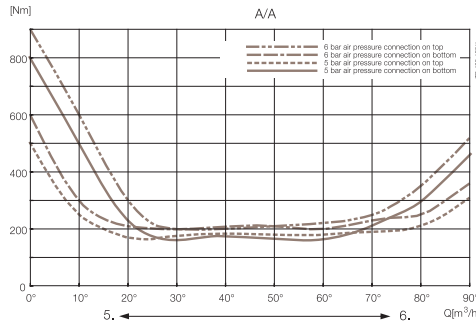
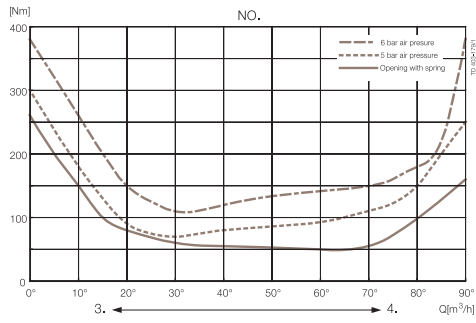
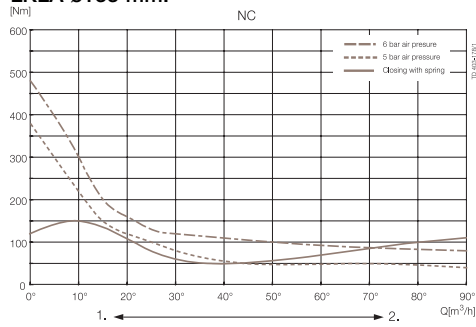

Torque values (for rotating the valve disc in a dry seal ring)

Size	Max. Nm
25mm/DN25	15
DN32	15
38mm/DN40	15
51mm/DN50	20
63.5mm/DN65	25
76mm/DN80	30
101.6mm/DN100	35
DN125	50
DN150	120

Angular motion of actuator:

1. Closing - Spring activated
2. Opening - Air activated
3. Closing - Air activated
4. Opening - Spring activated
5. Closing
6. Opening

Fig. 1. Dimensions - valve.

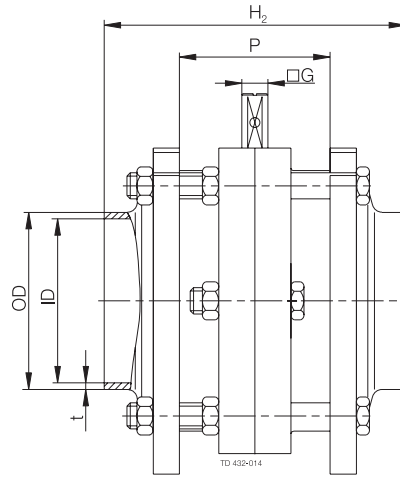
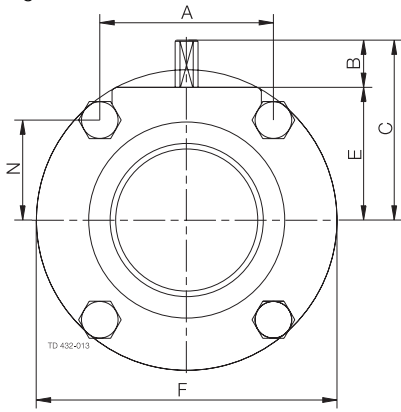

a. LKB-F.

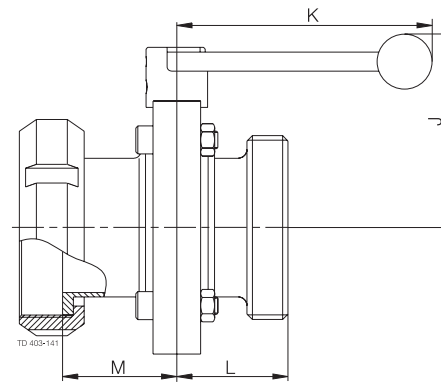
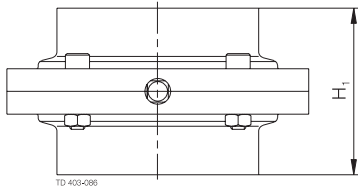

b. LKB with welding ends.

Note! LKB sizes DN 125 and 150 are with six screws.

c. LKB with male part/nut and liner.

Fig. 2. Dimensions - actuators.

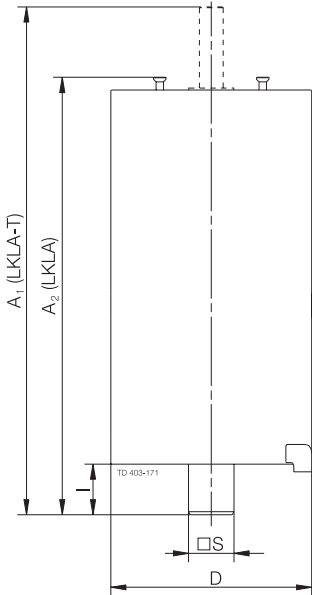

a. Without coupling.

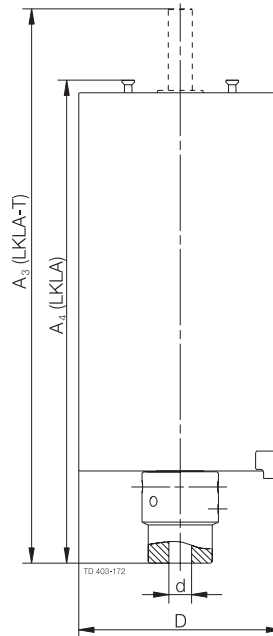

b. With coupling.

Dimensions (mm) - Valve

LKB, LKB-2, LKB-F:

Size	25	38	51	63.5	76.1	101.6	DN	DN	DN	DN	DN	DN	DN	DN	DN
	mm	mm	mm	mm	mm	mm	25	32	40	50	65	80	100	125	150
A	42.0	42.0	61.0	61.0	79.5	106.0	42.0	42.0	42.0	61.0	61.0	79.0	106.0	106.0	98.0
B	15.5	16.7	16.6	17.5	16.6	16.0	14.7	15.9	16.7	16.6	17.5	16.0	16.0	18.0	18.0
C	49.0	49.0	58.5	69.5	73.5	93.0	48.0	49.0	54.0	63.0	75.0	79.0	93.0	115.0	122.0
OD	25.6	38.6	51.6	64.1	76.6	102.2	30.0	36.0	42.0	54.0	70.0	85.0	104.0	129.0	154.0
ID	22.5	35.5	48.5	60.5	72.0	97.6	26.0	32.0	38.0	50.0	66.0	81.0	100.0	125.0	150.0
t	1.55	1.55	1.55	1.8	2.3	2.3	2.0	2.0	2.0	2.0	2.0	2.0	2.0	2.0	2.0
E	32.5	32.5	42.0	52.0	57.0	77.0	33.3	33.3	37.7	46.6	57.3	63.0	77.0	96.7	104.0
F	78.0	78.0	99.0	117.0	132.0	169.0	79.0	79.0	86.5	105.7	125.0	143.0	169.0	199.0	215.0
G	8.0	8.0	8.0	8.0	10.0	12.0	8.0	8.0	8.0	8.0	10.0	10.0	12.0	14.0	15.0
H ₁	47.0	47.0	52.0	54.0	62.0	80.0	47.0	47.0	47.0	52.0	62.0	64.0	80.0	110.0	80.0
H ₂	83.0	83.0	92.0	92.0	114.0	132.0	83.0	83.0	83.0	92.0	114.0	116.0	132.0	136.0	152.0
J	82.0	82.0	92.0	102.0	107.0	127.0	74.0	74.0	78.0	88.0	98.0	104.0	118.0	150.0	161.0
K	120.0	120.0	120.0	120.0	162.0	162.0	120.0	120.0	120.0	120.0	162.0	162.0	162.0	223.0	338.0
L IDF/ISO	45.0	45.0	47.5	48.5	52.5	61.5	-	-	-	-	-	-	-	-	-
M IDF/ISO	55.5	55.5	58.0	59.0	63.0	81.5	-	-	-	-	-	-	-	-	-
L DS	42.0	43.5	46.0	51.0	55.0	64.0	-	-	-	-	-	-	-	-	-
M DS	54.5	54.5	57.0	59.0	63.0	72.0	-	-	-	-	-	-	-	-	-
L SMS	38.5	43.5	46.0	51.0	55.0	75.0	-	-	-	-	-	-	-	-	-
M SMS	51.0	52.5	55.0	56.0	61.0	72.0	-	-	-	-	-	-	-	-	-
L BS	45.7	45.7	48.2	49.2	53.2	67.0	-	-	-	-	-	-	-	-	-
M BS	50.5	50.5	53.0	54.0	58.0	71.8	-	-	-	-	-	-	-	-	-
L DIN	45.5	45.5	48.0	52.0	61.0	70.0	40.0	40.0	37.0	37.0	43.0	48.0	51.0	55.0	115.0
M DIN	61.5	61.5	66.0	67.0	71.0	83.0	45.5	48.5	49.5	54.0	63.0	69.0	84.0	89.0	77.0
L Clamp	45.0	45.0	47.5	48.5	52.5	61.5	-	-	-	-	-	-	-	-	-
N	26.5	26.5	30.5	40.5	43.5	53.0	27.3	27.3	31.7	35.1	45.8	49.5	53.0	72.7	85.0
P	42.0	42.0	46.0	46.0	58.0	58.0	42.0	42.0	42.0	46.0	58.0	58.0	58.0	62.0	78.0
Weight LKB-F (kg)	1.6	1.3	2.1	2.9	5.0	7.9	1.6	1.6	1.7	2.6	4.7	5.8	7.9	11.7	12.3
Weight LKB/ LKB-2 (kg)	1.2	1.0	1.5	2.1	3.0	4.7	1.2	1.1	1.3	1.8	3.0	3.5	5.1	7.5	9.0

NOTE! Weights are for valves with welding ends and handles.

Dimensions (mm) - Actuator

LKLA and LKLA-T:

Valve size	25-63.5	76.1	101.6	101.6	DN125	DN125	DN150	DN150
	DN25-50	DN65-80	DN100	DN100				
A ₁	244	242	242	363	246	363	246	363
A ₂	193	191	191	316	195	316	195	316
A ₃	244	244	244	337	244	337	244	337
A ₄	173	173	173	290	173	290	173	290
D	85	85	85	133	85	133	85	133
d	17	17	17	30	20	30	20	30
l	16.5	16.5	16.5	34	16.5	34	16.5	34
S	8	10	12	12	14	14	15	15
Function	NC,NO,A/A	NC,NO,A/A	NC,NO,A/A	NC,NO,A/A	A/A	NC,NO,A/A	A/A	NC,NO,A/A

Connections

Compressed air

R1/8" (BSP), internal thread.

Capacity/Pressure drop diagrams

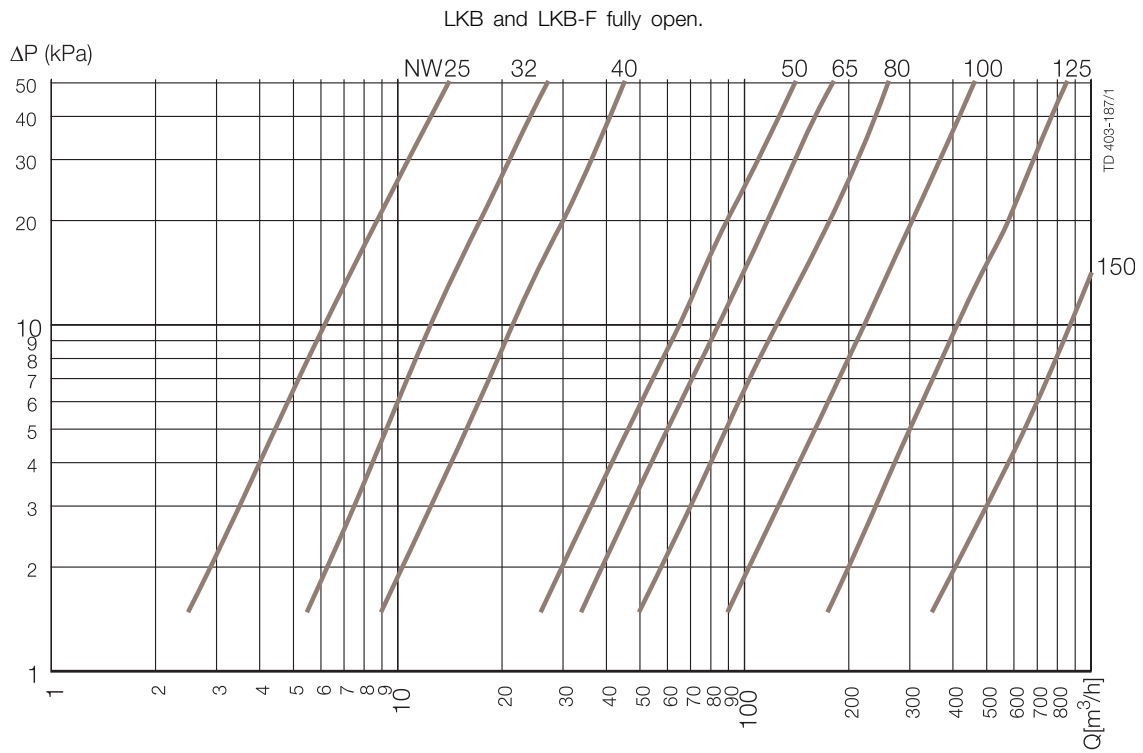
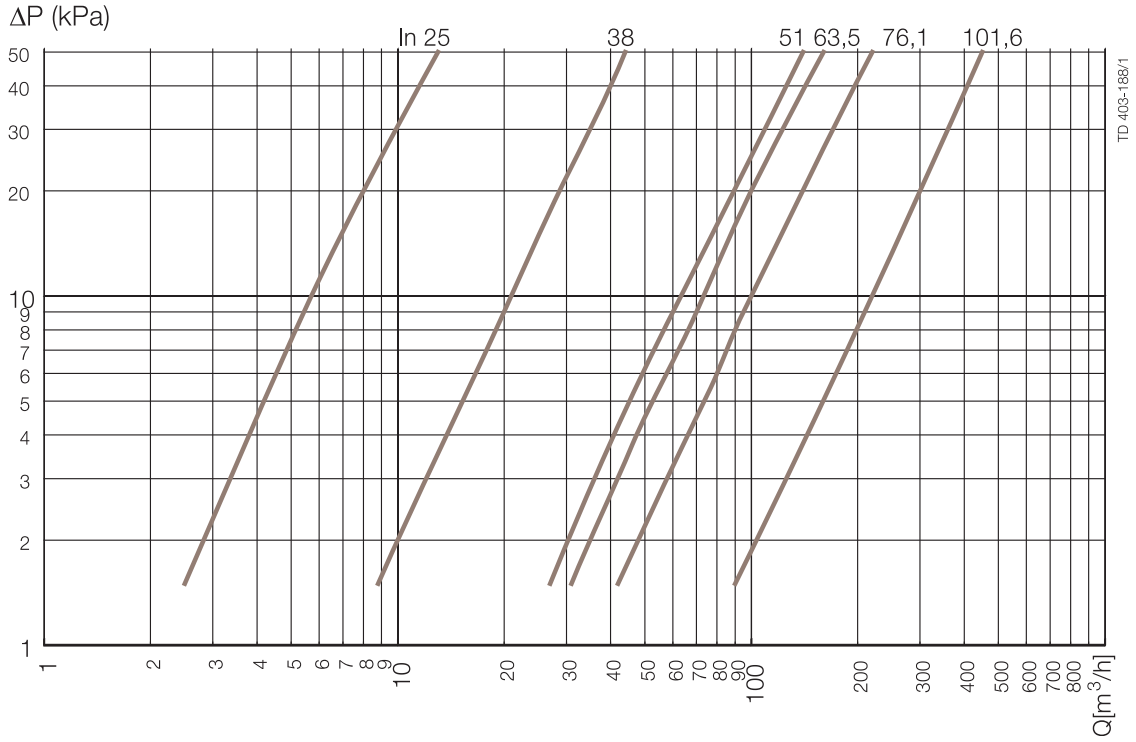

LKB-2 and LKB-F fully open.

NOTE!

For the diagrams the following applies:

Medium: Water (20°C).

Measurement: In accordance with VDI 2173.

Options

- A. Male parts or clamp liners in accordance with required standard.
 - B. ThinkTop® for control and indication.*
 - C. Indication unit with micro switches.*
 - D. Indication unit with inductive proximity switches.*
 - E. Indication unit with Hall proximity switches.*
 - F. Explosion proof indication unit with inductive proximity switches.*
 - G. Bracket for actuator. (Also for ball valves).
 - H. Handle with two or four positions (standard on DN125 and DN150).
 - I. Handle for electrical position indication.
 - J. Handle with infinite intermediate positions (not for DN125 and DN150).
 - K. Multipositioning handle**.
 - L. Lockable Multiposition Handle. Padlock can be mounted as shown in fig. 5.
- Note!** Padlock is not delivered.
- M. Special cap for 90° turned handle position.
 - N. Service tool for actuator.
 - O. Service tool for fitting 25-38 mm (DN25 - DN40) valve discs.

* For further information see Product Catalogue chapter "Control & Indication".

** A padlock can be mounted on the Lockable Multiposition Handle as shown in the opposite figure.

Note! Padlock is not delivered.

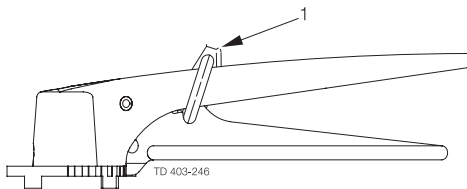

Fig. 3. Lockable Multiposition Handle with padlock.

1. Padlock

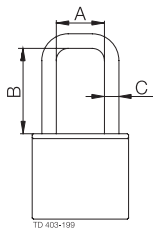

Fig. 4. Dimensions - padlock.

A. Min. 20 mm

B. Min. 35 mm

C. $\varnothing 6$ mm

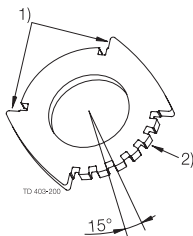

Fig. 5. Positioning cap.

1. On/Off

2. Multi positioning

Ordering

Please state the following when ordering:

- Valve type: LKB, LKB-2 or LKB-F.
- Valve size.
- Connections, if not welding ends.
- Materials: 1.4307 (304L) or 1.4404 (316L).
- Rubber grade: EPDM, Silicone (Q), Fluorinated rubber (FPM), HNBR or PFA.
- Type of handle, if required.

If ordering with actuator:

- Type: LKLA or LKLA-T.
- Size: ø85mm or ø133mm.
- Function: NC, NO or Air/Air.
- Other options.

Note!

For further details, see also IM 70730.

ESE00285EN 1001

The information contained herein is correct at the time of issue,
but may be subject to change without prior notice.

How to contact Alfa Laval

Contact details for all countries
are continually updated on our website.
Please visit www.alfalaval.com to
access the information direct.